

SINGER

7-33

Form 20537
Rev. (765)
Printed in U. S. A.

INSTRUCTIONS
FOR USING AND ADJUSTING
SINGER*
SEWING MACHINE
7-33

ONE NEEDLE

LOCK STITCH

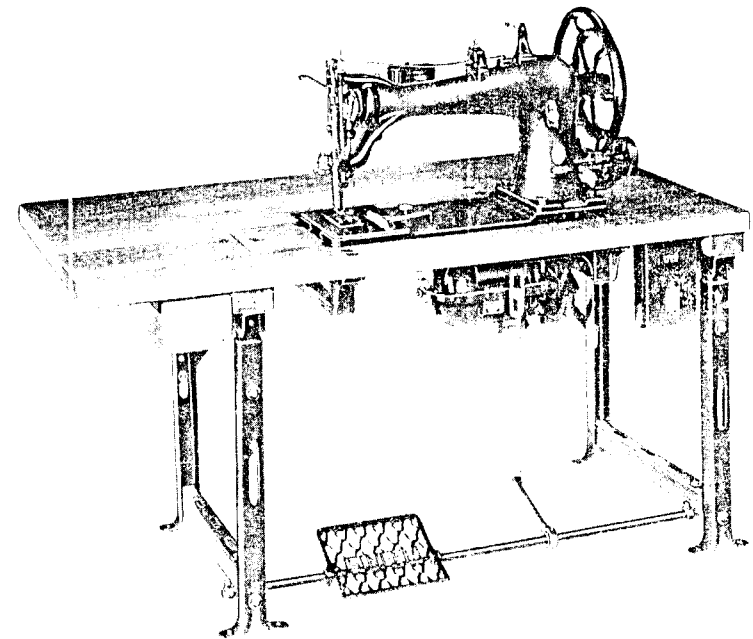

THE SINGER COMPANY

*A Trademark of THE SINGER COMPANY

Keystone Sewing Machine Company, Inc.

To all whom it may concern:

The improper placing or renewal of the trademark "**SINGER**" or any other of the trademarks of The Singer Company (all of which are duly Registered Trademarks) on any machine that has been repaired, rebuilt, reconditioned, or altered in any way whatsoever outside a SINGER factory or an authorized SINGER agency is forbidden.

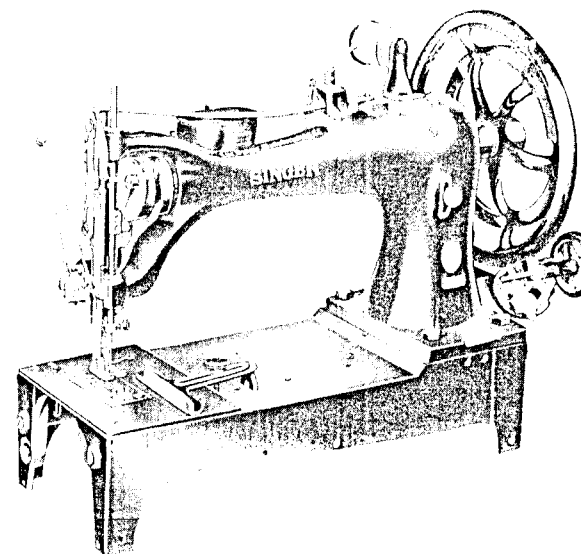

DESCRIPTION

Machine 7-33, single needle, lock stitch, is designed for sewing heavy canvas and similar work.

It is equipped with alternating pressers, drop feed and long beak oscillating shuttle on a horizontal axis. It has a clearance of $9/16$ inch under the presser feet. Clearance, on bed, at right of needle is $15-7/8$ inches and length of bed is $25-1/4$ inches.

Stitch regulation provides for stitches ranging in length from 2 to 8 to the inch.

The machine is regularly fitted with a two-row feed dog which feeds at both sides of the needle. Fittings for feeding at the left side of the needle can be furnished, if so ordered.

Alternating pressers consist of a vibrating presser foot and a lifting presser foot working in combination. In operation, the pressers alternately press down on the material, the vibrating presser working in unison with the feed, so that there is no slipping of the two or more plies of material which are being sewn.

The machine is also equipped with an adjustable edge guide and an automatic bobbin winder.

SPEED

The maximum speed is 550 stitches per minute.

The balance wheel should always turn over toward the operator.

Copyright, U. S. A., 1914, 1916, 1935, 1937, 1948 and 1951

by The Singer Company

All Rights Reserved for All Countries

NEEDLES

Needles for Machine 7-33 are of Class and Variety as follows:

7x1, Sizes 19, 21, 22, 23, 24, 25, 26, 27	} for cloth
or 7x5, Sizes 28, 29, 30, 31	
7x2, Sizes 18, 19, 21, 22, 23, 24, 25, 26, 27	} for leather
or 7x6, Sizes 28, 29, 30, 31	

The size of the needle to be used depends upon the size of the thread which must pass freely through the eye of the needle.

Do not use rough or uneven thread or thread which passes with difficulty through the needle eye, as such thread will interfere with the successful use of the machine.

Orders for needles must specify the **Quantity** required, the **Size** number, also the **Class** and **Variety** numbers, separated by an **x**.

The following is an example of an intelligible order:

"100 No. 19, 7x1 Needles
100 No. 28, 7x5 Needles"

The best stitching results will be obtained with needles sold by The Singer Company.

THREAD

Left twist thread should be used in the needle. Either right twist or left twist thread can be used in the bobbin.

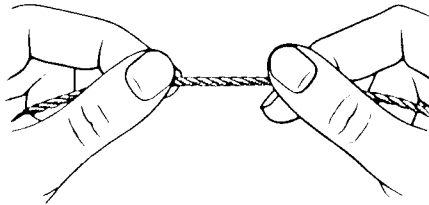

Fig. 3. How to Determine the Twist

Hold the thread as shown in **Fig. 3**. Turn the thread over toward you between the thumb and forefinger of the right hand. If left twist, the strands will wind tighter. If right twist, the strands will unwind.

TO REMOVE THE BOBBIN

Turn the balance wheel to bring the needle bar to its lowest position; then, with the curve of the Shuttle Cylinder Opener 120571, shown in **Fig. 4**, conforming to the curve of the shuttle cylinder, insert the small end of the shuttle cylinder opener in the slot **B** in the

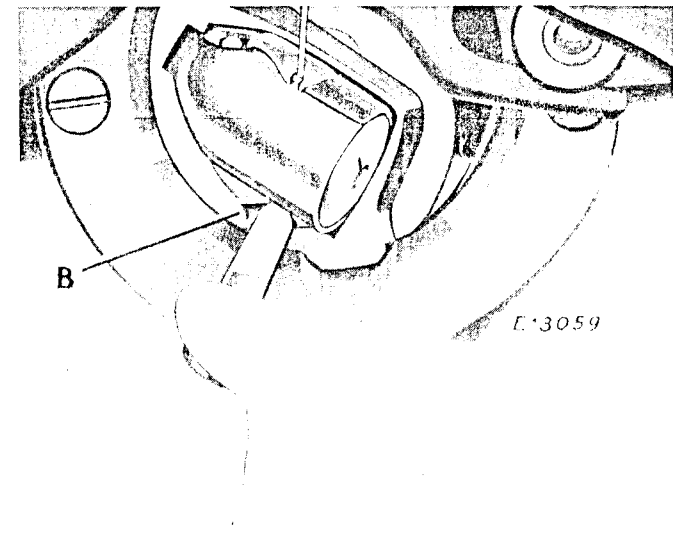

Fig. 4. Shuttle Cylinder Opener 120571 in Use

spring latch beneath the shuttle cylinder, as shown in **Fig. 4**. Press the latch away from the cylinder and turn the cylinder outward or toward the left as far as it will go, as shown in **Fig. 4**, and the bobbin will drop out.

TO WIND THE BOBBIN

Place the bobbin on the bobbin winder spindle and push it up closely against the shoulder, having the small pin in the shoulder enter the slot in the bobbin.

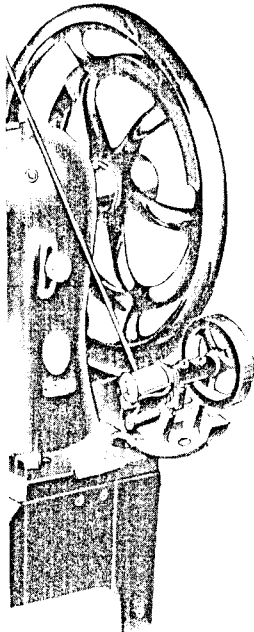

Fig. 5. Winding the Bobbin

Pass the thread from the unwinder through the hole in the left side of the bobbin from the inside. Push the bobbin winder pulley up against the balance wheel and place the bobbin winder latch in position as shown in **Fig. 5**. Then start the machine. The end of the thread must be held until a few coils are wound, and should then be cut off. When sufficient thread has been wound upon the bobbin, the bobbin winder will stop automatically.

TO REPLACE THE BOBBIN AND THREAD THE SHUTTLE

Take the bobbin between the thumb and forefinger of the left hand, with the thread drawing off from the underside toward the right as shown in **Fig. 6**, page 7. Place the bobbin in the cylinder as far as it will go, draw the thread into the slot **1**, **Fig. 6** in the

cylinder and under the tension spring into the delivery eye **2**, **Fig. 6**, then push the cylinder back until it is locked by the spring latch.

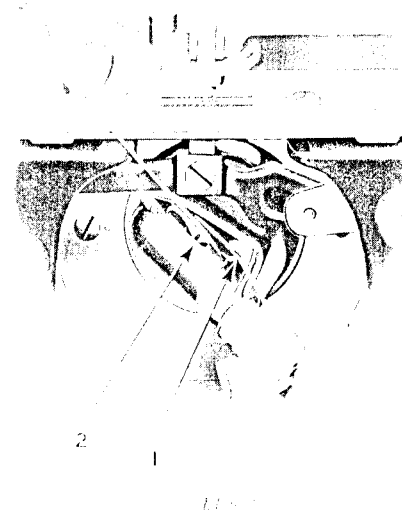

Fig. 6. Replacing the Bobbin and Threading the Shuttle

and allow about three inches of thread to hang free from the shuttle so that it can be drawn up through the throat plate, as shown in **Fig. 10**.

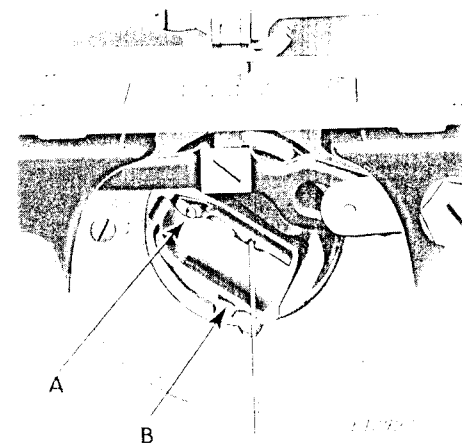

Fig. 7. Bobbin Replaced and Shuttle Threaded

TO SET THE NEEDLE

Turn the balance wheel over toward you until the needle bar moves up to its highest position; loosen the set screw in the needle clamp and put the needle up into the clamp as far as it will go, with the long groove of the needle toward the left and the eye directly in line with the arm of the machine, then tighten the set screw.

TO THREAD THE NEEDLE

Operator Facing Front of Machine

Turn the balance wheel over toward you until the thread take-up lever 8, Fig. 9, on page 9, moves up to its highest position.

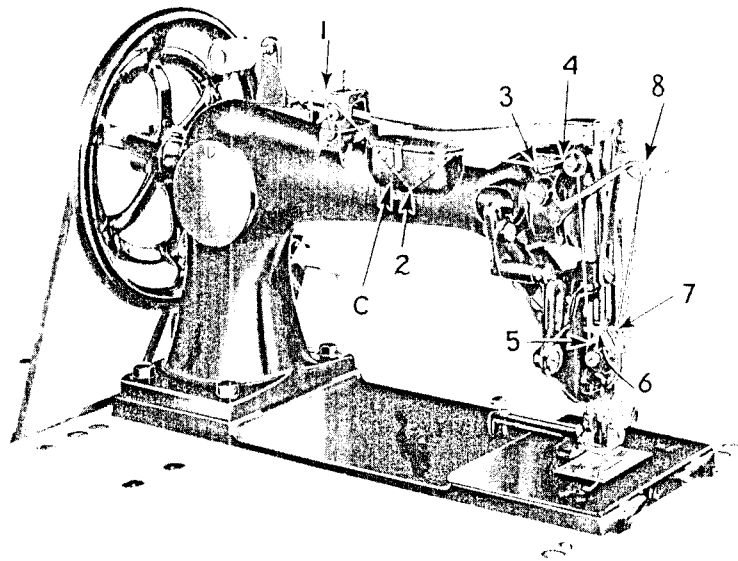

Fig. 8. Threading the Needle

Pass the thread from the unwinder, or from the spool on the spool pin on top of the machine, through the eyelet 1, Fig. 8. Raise the lid of the cup C, Fig. 8 and pass the thread through the hole at the end of the thread post 2, Fig. 8 under the lid. Then close the lid and pass the thread through the eyelet 3, Fig. 8, over from right to left between the thread retainer discs 4, Fig. 8, down under and from right to left around the tension wheel 5, Fig. 8, into the loop of the thread take-up spring 6, Fig. 8, under the staple 7, Figs. 8 and 9, up and from back to front through the hole 8, Figs. 8 and 9, in the thread take-up lever, down through the thread guide 9, Fig. 9, into the slot 10, Fig. 9 in the vibrating presser bar, into thread

guide 11, Fig. 9 on the needle clamp, and from left to right through the eye of the needle 12, Fig. 9, then pass the thread down through

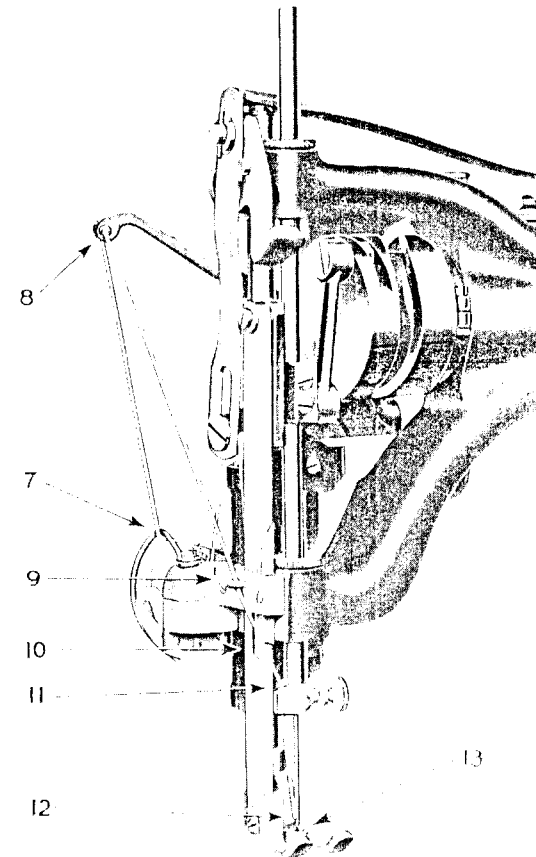

Fig. 9. Threading the Needle

the hole in the lifting presser foot 13, Fig. 9. Draw about four inches of thread through the hole in the lifting presser foot with which to pull up the bobbin thread, as shown in Fig. 10.

If it is not desired to oil the thread, the thread should be omitted from the cup C, Fig. 8.

TO PREPARE FOR SEWING

With the left hand hold the end of the needle thread, leaving it slack from the hand to the needle. Turn the balance wheel over

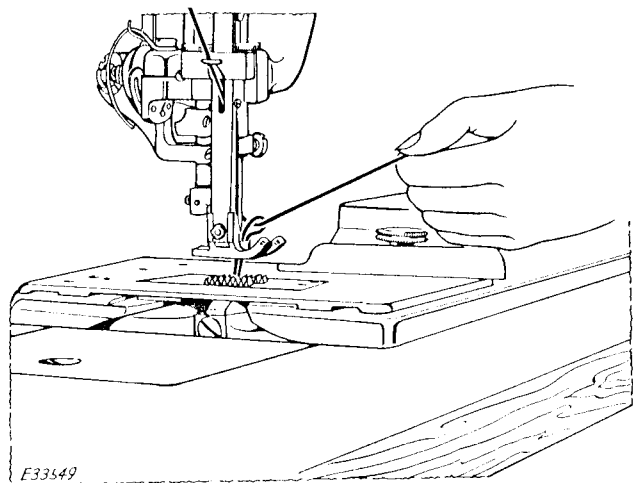

Fig. 10. Drawing Up the Bobbin Thread

toward you until the needle moves down and up again to its highest position, thus catching the bobbin thread; draw up the needle thread and the bobbin thread will come up with it through the hole in the throat plate (see Fig. 10). Lay both threads back under the presser feet.

TO COMMENCE SEWING

Place the material beneath the presser feet, lower the presser feet and turn the balance wheel over toward you to begin sewing.

TO REMOVE THE WORK

Stop the machine with the thread take-up lever resting at its highest position; draw about three inches of thread through the thread retaining discs, raise the presser feet, draw the work back and cut the threads close to the goods. Leave the ends of the threads under the presser feet.

TENSIONS

For ordinary stitching, the needle and bobbin threads should be locked in the center of the thickness of the material, thus:

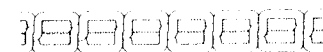

Fig. 11. Perfect Stitch

If the tension on the needle thread is too tight, or if that on the bobbin thread is too loose, the needle thread will lie straight along the upper surface of the material, thus:



Fig. 12. Tight Needle Thread Tension

If the tension on the bobbin thread is too tight or if that on the needle thread is too loose, the bobbin thread will lie straight along the under side of the material, thus:



Fig. 13. Loose Needle Thread Tension

TO REGULATE THE TENSIONS

The tension on the needle thread is regulated by the thumb nut **H**, Fig. 15, page 13 at the front of the thread retainer discs, and the thumb nut **J**, Fig. 15, page 13 at the front of the tension wheel. The tension on the thread retainer discs should be only enough to cause the tension wheel to turn when the thread is taken from the spool.

The tension on the bobbin thread is regulated by the screw **A**, Fig. 7, page 7 which holds the tension spring to the cylinder. To increase the tension, turn the screw over to the right. To decrease the tension, turn the screw over to the left.

TO REGULATE THE LENGTH OF STITCH

The length of the stitch is regulated by the thumb screw **G**, **Fig. 14** in the slot on the front of the upright part of the arm. To lengthen the stitch, loosen the thumb screw and move it downward. To shorten the stitch, loosen the thumb screw and move it upward. When the desired length of stitch is obtained, tighten the thumb screw.

TO REGULATE THE PRESSURE ON THE MATERIAL

The pressure on the material is regulated by means of the hexagon head screw **D**, **Fig. 14**. Loosen the hexagon head lock nut **E**, **Fig. 14** and turn the screw **D** to the right to increase the pressure, or to the left to decrease the pressure. When the desired pressure has been obtained, hold the screw **D** with a wrench to keep it from turning while the lock nut **E** is being tightened against the bracket **F**.

The pressure should be only heavy enough to enable the feed to move the work along evenly, and to prevent the work from rising with the needle.

TO OIL THE MACHINE

Use "TYPE B" or "TYPE D" OIL, sold by The Singer Company.

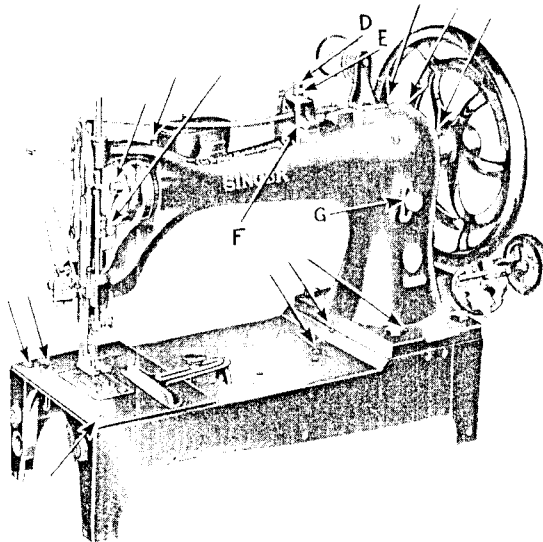

Fig. 14. Oiling Points at Front of the Machine

To insure easy running and prevent unnecessary wear of the machine, all parts which are in movable contact require oiling, and when the machine is in continuous use, oil should be applied frequently. The places where the machine should be oiled are in-

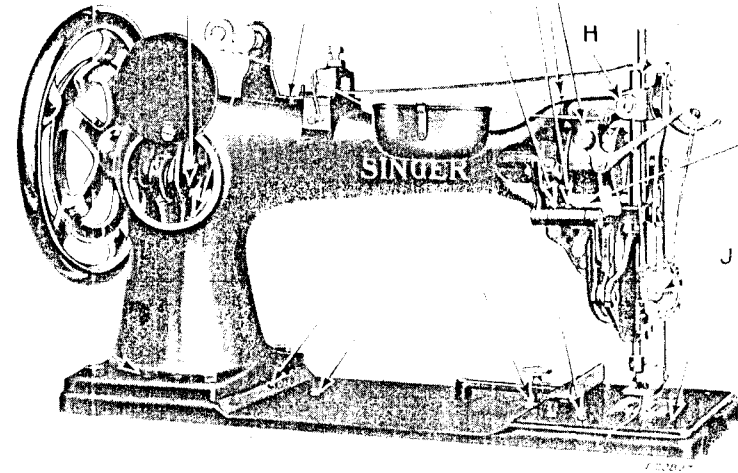

Fig. 15. Oiling Points at Back of Machine

dicated in **Figs. 14** and **15** by arrows pointing to the oil holes and bearings. Oil should be regularly applied to the shuttle race.

On the back of the arm is a round plate or cover, fastened by a screw; loosen the screw, turn the plate upward and fasten by tightening the screw. Care should be taken to see that all the moving parts inside are sufficiently lubricated. Then turn the cover back into position and tighten the screw.

TO SET THE NEEDLE BAR

When the shuttle point is at the centre of the needle, the top of the needle eye should be approximately $1/32$ inch below the point of the shuttle.

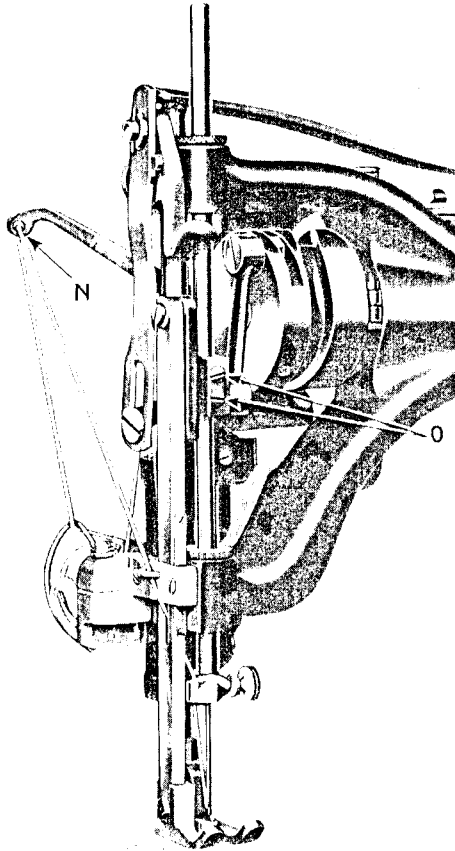

Fig. 16. Setting the Needle Bar

To adjust, loosen the two set screws **O**, Fig. 16 and move the needle bar up or down as required, then securely tighten the set screws **O**.

NOTE—This setting of the needle bar may be varied slightly depending upon the size of the needle and the thread being used.

TO SET THE SHUTTLE WITH RELATION TO THE NEEDLE

The shuttle can be adjusted for proper clearance between the shuttle point and the needle.

If a change is made from a very small needle to a much larger one, the shuttle point will perhaps pass too close to the needle, or too far away from it if the change is from a large to a much smaller needle.

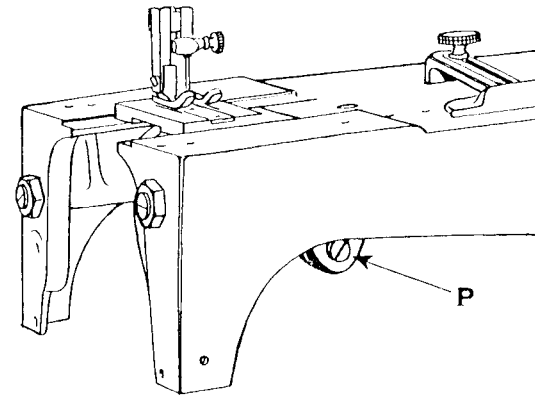

Fig. 17. Setting the Shuttle with Relation to the Needle

In such cases, loosen the clamping screw **P**, Fig. 17 beneath the machine bed, and move the shuttle race slightly to right or left to suit the needle being used, then securely tighten the clamping screw **P**.

TO TIME THE FEED

For general sewing conditions, the feed dog should be so timed that it will have completed its feeding action at approximately the same time that the take-up lever **N**, Fig. 16 completes its upward stroke.

When the machines leave the factory THEY ARE PROPERLY TIMED, AND NO ADJUSTMENT IS NECESSARY UNLESS THE POSITION OF THE FEED CAM HAS BEEN DISTURBED.

If adjustment should be considered necessary, remove the arm side cover at the rear side of the machine arm. The feed cam is easily accessible with the arm side cover removed. This cam is provided with two screws. Loosen these two screws and set the cam for earlier or later movement of the feed dog, as required, by turning the cam about the arm shaft to the required position, then securely tighten the two screws in the cam.